

# 板式链 Leaf chains

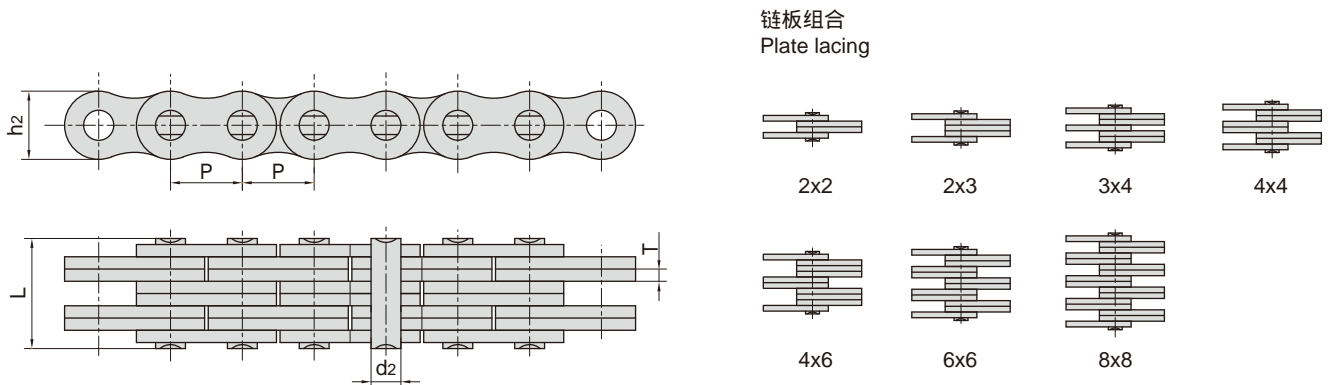

ISO 链号 ISO Chain No.	ANSI 链号 ANSI Chain No.	节距 Pitch	链板组合 Plate lacing	链板高度 Plate depth	链板厚度 Plate thickness	销轴直径 Pin diameter	销轴长度 Pin length	抗拉强度 Tensile strength	平均抗拉强度 Average tensile strength	每米长重 Weight per meter
		P		h2 max	T max	d2 max	L max	Q min	Q0	q
		mm		mm	mm	mm	mm	kN/lbf	kN	kg/m
LH0822	BL422	12.700	2 × 2	12.07	2.03	5.09	11.05	22.2/5045	27.6	0.60
LH0823	BL423		2 × 3				13.16	22.2/5045	27.6	0.75
LH0834	BL434		3 × 4				17.40	33.4/7591	41.4	1.05
LH0844	BL444		4 × 4				19.51	44.5/10114	56.0	1.20
LH0846	BL446		4 × 6				23.75	44.5/10114	56.0	1.46
LH0866	BL466		6 × 6				27.99	66.7/15159	81.7	1.77
LH0888	BL488		8 × 8				36.45	89.0/20227	109.4	2.32
LH1022	BL522	15.875	2 × 2	15.09	2.42	5.96	12.90	33.4/7591	43.1	0.90
LH1023	BL523		2 × 3				15.37	33.4/7591	43.1	1.10
LH1034	BL534		3 × 4				20.32	48.9/11114	65.6	1.50
LH1044	BL544		4 × 4				22.78	66.7/15159	84.5	1.80
LH1046	BL546		4 × 6				27.74	66.7/15159	84.5	2.20
LH1066	BL566		6 × 6				32.69	100.1/22750	125.1	2.65
LH1088	BL588		8 × 8				42.57	133.4/30318	169.5	3.50
LH1222	BL622	19.050	2 × 2	18.11	3.25	7.94	17.37	48.9/11114	68.2	1.50
LH1223	BL623		2 × 3				20.73	48.9/11114	68.2	1.80
LH1234	BL634		3 × 4				27.43	75.6/17181	102.8	2.50
LH1244	BL644		4 × 4				30.78	97.9/22250	136.9	2.90
LH1246	BL646		4 × 6				37.49	97.9/22250	136.9	3.60
LH1266	BL666		6 × 6				44.20	146.8/33364	214.2	4.30
LH1288	BL688		8 × 8				57.61	195.7/44477	217.7	5.80
LH1622	BL822	25.400	2 × 2	24.13	4.00	9.54	21.34	84.5/19204	108.2	2.40
LH1623	BL823		2 × 3				25.48	84.5/19204	108.2	3.00
LH1634	BL834		3 × 4				33.76	129.0/29318	170.0	4.20
LH1644	BL844		4 × 4				37.90	169.0/38409	214.6	4.80
LH1646	BL846		4 × 6				46.18	169.0/38409	214.6	6.00
LH1666	BL866		6 × 6				54.46	253.6/57636	324.5	7.20
LH1688	BL888		8 × 8				71.02	338.1/76841	432.7	9.60

# 板式链 Leaf chains

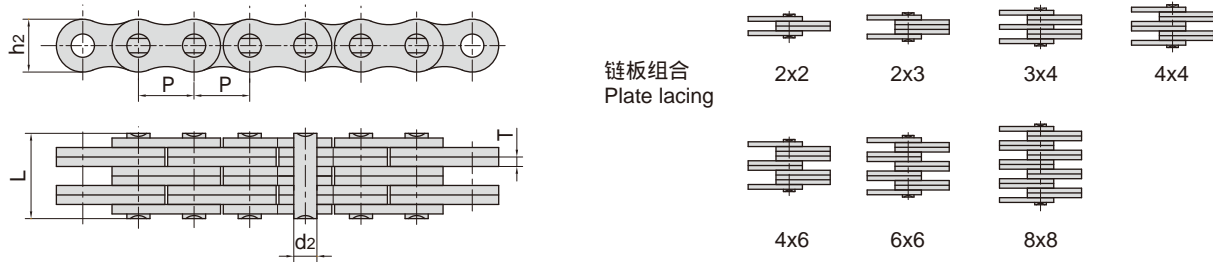

ISO 链号 ISO Chain No.	ANSI 链号 ANSI Chain No.	节距	链板组合	链板高度	链板厚度	销轴直径	销轴长度	抗拉强度	平均抗拉强度	每米长重
		Pitch	Plate lacing	Plate depth	Plate thickness	Pin diameter	Pin length	Tensile strength	Average tensile strength	Weight per meter
		P		h2 max	T max	d2 max	L max	Q min	Q0	q
		mm		mm	mm	mm	mm	kN/lbf	kN	kg/m
LH2022	BL1022	31.75	2 × 2	30.18	4.80	11.11	25.37	115.6/26272	165.8	3.57
LH2023	BL1023		2 × 3				30.33	115.6/26272	165.8	4.45
LH2034	BL1034		3 × 4				40.23	182.4/41454	248.7	6.19
LH2044	BL1044		4 × 4				45.19	231.3/52568	303.6	7.04
LH2046	BL1046		4 × 6				55.09	231.3/52568	303.6	8.77
LH2066	BL1066		6 × 6				65.00	347.0/78863	433.7	10.50
LH2088	BL1088		8 × 8				84.81	462.6/105136	604.1	14.00
LH2422	BL1222	38.10	2 × 2	36.20	5.60	12.71	29.62	151.2/34363	192.0	4.96
LH2423	BL1223		2 × 3				35.43	151.2/34363	192.0	6.16
LH2434	BL1234		3 × 4				47.07	244.6/55591	315.9	8.55
LH2444	BL1244		4 × 4				52.88	302.5/68750	381.1	9.76
LH2446	BL1246		4 × 6				64.52	302.5/68750	381.1	12.16
LH2466	BL1266		6 × 6				76.15	453.7/103113	543.6	14.61
LH2488	BL1288		8 × 8				99.42	605.0/137500	726.0	19.36
LH2822	BL1422	44.45	2 × 2	42.24	6.40	14.29	33.55	191.3/43477	225.7	6.89
LH2823	BL1423		2 × 3				40.16	191.3/43477	225.7	8.55
LH2834	BL1434		3 × 4				53.37	315.8/71772	448.3	11.61
LH2844	BL1444		4 × 4				59.97	382.6/86954	451.2	13.24
LH2846	BL1446		4 × 6				73.18	382.6/86954	451.2	16.51
LH2866	BL1466		6 × 6				86.39	578.3/131431	682.4	19.79
LH2888	BL1488		8 × 8				112.80	765.1/173886	902.8	26.35
LH3222	BL1622	50.80	2 × 2	48.26	*7.20	17.46	39.01	289.1/65704	341.1	8.78
LH3223	BL1623		2 × 3				46.58	289.1/65704	341.1	10.90
LH3234	BL1634		3 × 4				61.72	440.4/100091	519.6	15.15
LH3244	BL1644		4 × 4				69.29	573.8/131431	680.4	17.27
LH3246	BL1646		4 × 6				84.43	578.3/131431	680.4	21.53
LH3266	BL1666		6 × 6				99.57	857.4/194863	1000.7	25.88
LH3288	BL1688		8 × 8				129.84	1156.5/262841	1364.6	34.29
LH4022	BL2022	63.50	2 × 2	60.33	9.91	23.81	51.74	433.7/98568	511.7	15.95
LH4023	BL2023		2 × 3				61.70	433.7/98568	511.7	19.78
LH4034	BL2034		3 × 4				81.61	649.4/147590	766.2	27.46
LH4044	BL2044		4 × 4				91.57	867.4/197163	1023.5	31.34
LH4046	BL2046		4 × 6				111.48	867.4/197163	1023.5	39.01
LH4066	BL2066		6 × 6				131.39	1301.1/295704	1535.2	46.63
LH4088	BL2088		8 × 8				171.22	1734.8/394272	2046.5	62.00

\* : 有两种链板厚度，除上述表中标注的7.20mm之外，另一种厚度为7.52mm。客户可根据自己的需求，自行选择。

\*: We have two kinds of chain plate thickness. Besides the 7.20mm in above table, the other thickness is 7.52 mm. Customers can choose according to needs.

# 板式链

## Leaf chains

链板组合  
Plate lacing

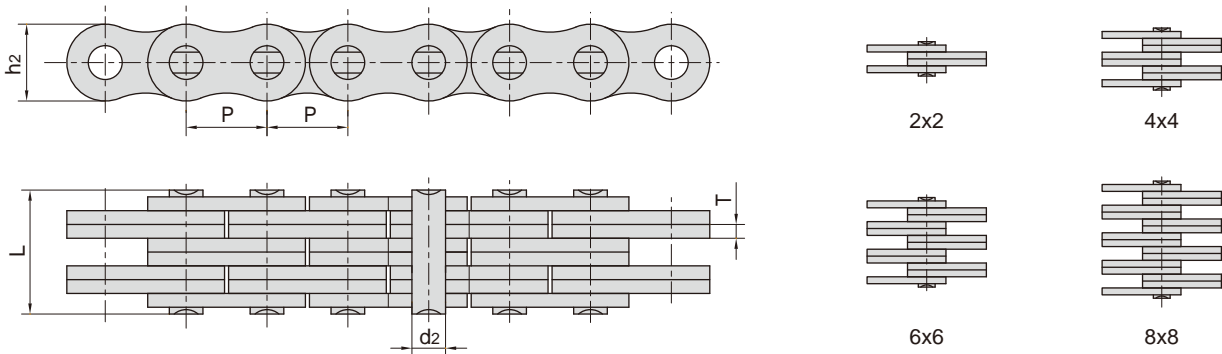

DIN/ISO 链号 DIN/ISO Chain No.	节距 Pitch	链板组合 Plate lacing	链板高度 Plate depth	链板厚度 Plate thickness	销轴直径 Pin diameter	销轴长度 Pin length	抗拉强度 Tensile strength	平均抗拉强度 Average tensile strength	每米重量 Weight per meter
	P		h2 max	T max	d2 max	L max	Q min	Q0	q
	mm		mm	mm	mm	mm	kN/lbf	kN	kg/m
LL0622	9.525	2 × 2	8.2	1.04	3.28	6.2	9.0/2023	9.9	0.22
LL0644		4 × 4				10.7	18.0/4046	19.8	0.42
LL0666		6 × 6				14.9	24.9/5598	27.4	0.62
LL0822	12.700	2 × 2	10.6	1.60	4.45	8.9	18.2/4094	20.4	0.42
LL0844		4 × 4				15.6	36.4/8188	40.7	0.84
LL0866		6 × 6				22.0	54.6/12283	60.0	1.24
LL0888		8 × 8				28.5	72.8/16378	80.0	1.64
LL1022	15.875	2 × 2	13.7	1.60	5.08	9.2	22.7/5107	25.5	0.54
LL1044		4 × 4				15.8	45.4/10213	51.0	1.06
LL1066		6 × 6				22.1	68.1/15321	76.3	1.57
LL1088		8 × 8				28.8	90.8/20427	101.9	2.10
LL1222	19.050	2 × 2	16.0	1.85	5.72	10.4	29.5/6637	33.2	0.73
LL1244		4 × 4				17.9	59.0/13273	66.4	1.44
LL1266		6 × 6				25.4	88.5/19910	99.7	2.15
LL1288		8 × 8				32.9	118.0/26547	132.9	2.84

# 板式链 Leaf chains

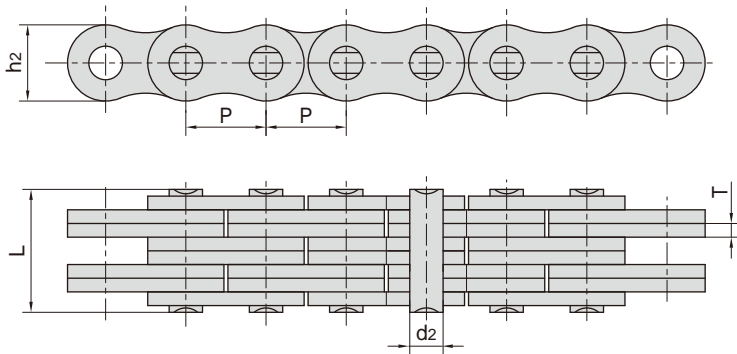

链板组合  
Plate lacing

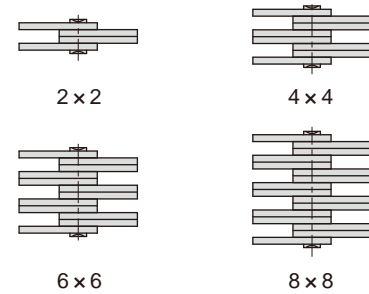

DIN/SIO 链号 DIN/ISO Chain No.	节距 Pitch	链板组合 Plate lacing	链板高度 Plate depth	链板厚度 Plate thickness	销轴直径 Pin diameter	销轴长度 Pin length	抗拉强度 Tensile strength	平均抗拉强度 Average tensile strength	每米重量 Weight per meter
	P		h2 max	T max	d2 max	L max	Q min	Q0	q
	mm		mm	mm	mm	mm	kN/lbf	kN	kg/m
LL1622	25.40	2 × 2	21.00	3.10	8.28	17.2	58.0/13182	76.3	1.52
LL1644		4 × 4				29.6	116.0/26363	152.6	2.90
LL1666		6 × 6				42.4	174.0/39545	228.9	4.30
LL1688		8 × 8				54.9	232.0/52726	305.2	5.71
LL2022	31.75	2 × 2	26.40	3.70	10.19	20.1	95.0/21591	109.2	2.33
LL2044		4 × 4				33.8	190.0/43182	218.5	4.40
LL2066		6 × 6				50.1	285.0/64773	324.6	6.79
LL2088		8 × 8				64.0	380.0/86363	435.1	8.90
LL2422	38.10	2 × 2	33.40	5.00	14.63	28.4	170.0/38363	195.5	4.47
LL2444		4 × 4				46.3	340.0/77273	380.8	8.22
LL2466		6 × 6				66.4	510.0/115909	571.2	12.22
LL2488		8 × 8				86.6	680.0/154545	775.2	16.30
LL2822	44.45	2 × 2	37.08	6.00	15.90	32.2	200.0/45455	245.0	5.40
LL2844		4 × 4				56.4	400.0/90909	490.0	10.53
LL2866		6 × 6				80.8	600.0/136363	735.0	15.68
LL2888		8 × 8				105.2	800.0/181818	980.0	20.83
LL3222	50.80	2 × 2	42.00	6.40	17.81	34.8	260.0/59091	291.2	6.39
LL3244		4 × 4				60.6	520.0/118182	582.4	12.46
LL3266		6 × 6				86.4	780.0/177272	873.6	18.52
LL3288		8 × 8				112.2	1040.0/233970	1176.0	24.65
LL4022	63.50	2 × 2	52.76	8.00	22.89	42.2	360.0/81818	403.2	10.36
LL4044		4 × 4				74.4	780.0/177273	873.6	20.22
LL4066		6 × 6				106.5	1080.0/245454	1209.6	30.07
LL4088		8 × 8				140.0	1440.0/323959	1747.2	39.98
LL4822	76.20	2 × 2	63.88	10.00	29.24	54.6	560.0/127272	627.2	15.94
LL4844		4 × 4				92.6	1120.0/254545	1554.4	31.38
LL4866		6 × 6				133.4	1680.0/377953	1880.0	46.94
LL4888		8 × 8				174.2	2240.0/509091	2508.8	62.36

# 板式链 Leaf chains

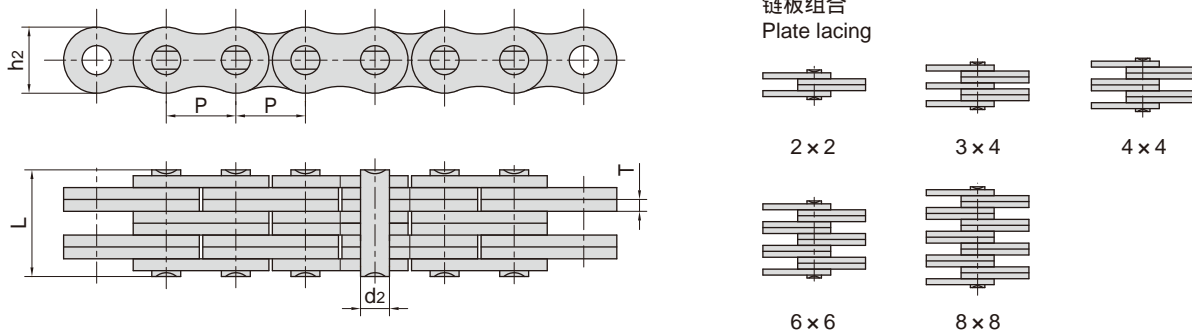

JIS 链号 JIS Chain No.	节距 Pitch	链板组合 Plate lacing	链板高度 Plate depth	链板厚度 Plate thickness	销轴直径 Pin diameter	销轴长度 Pin length	抗拉强度 Tensile strength	平均抗拉强度 Average tensile strength	每米长重 Weight per meter
	P		h <sub>2</sub> max	T max	d <sub>2</sub> max	L max	Q min	Q <sub>0</sub>	q
	mm		mm	mm	mm	mm	kN/lbf	kN	kg/m
AL322	9.525	2 × 2	7.7	1.30	3.58	6.80	9.0/2045	10.2	0.23
AL344		4 × 4				11.60	18.0/4090	20.0	0.46
AL422	12.700	2 × 2	10.4	1.50	3.96	8.30	14.7/3304	16.9	0.39
AL444		4 × 4				14.40	29.4/6609	35.2	0.74
AL466		6 × 6				20.50	44.0/9891	52.7	1.13
AL522	15.875	2 × 2	12.8	2.03	5.08	11.05	24.5/5508	28.6	0.64
AL534		3 × 4				17.00	36.8/8273	46.0	1.10
AL544		4 × 4				19.40	48.9/10993	62.4	1.25
AL566		6 × 6				27.50	73.4/16500	93.8	1.79
AL622	19.050	2 × 2	15.6	2.42	5.94	13.00	33.4/7508	44.4	0.87
AL644		4 × 4				22.70	66.7/14994	78.8	1.70
AL666		6 × 6				32.20	100.1/22502	118.6	2.53
AL688		8 × 8				42.20	133.4/29988	156.6	3.37
AL822	25.400	2 × 2	20.8	3.25	7.92	16.20	57.9/13016	68.6	1.57
AL844		4 × 4				29.40	115.7/26009	135.6	3.08
AL866		6 × 6				44.20	173.5/39003	202.3	4.62
AL888		8 × 8				55.50	231.4/52019	245.0	6.12
AL1022	31.750	2 × 2	25.6	4.00	9.53	19.60	84.5/18996	107.1	2.51
AL1044		4 × 4				36.40	169.0/37991	203.6	4.95
AL1066		6 × 6				52.30	253.5/56987	315.3	7.39
AL1088		8 × 8				68.50	338.0/75982	421.2	9.83
AL1222	38.100	2 × 2	30.5	4.80	11.10	24.30	120.1/26998	151.1	3.65
AL1244		4 × 4				43.80	240.2/53997	299.7	7.05
AL1266		6 × 6				63.20	360.3/80995	426.3	10.50
AL1288		8 × 8				82.60	480.4/107994	568.4	14.03
AL1444	44.450	4 × 4	36.4	5.60	12.70	51.30	302.5/68002	413.6	9.80
AL1466		6 × 6				74.50	453.7/101992	620.4	14.66
AL1644	50.800	4 × 4	41.6	6.40	14.21	58.00	382.5/85986	522.8	12.90
AL1666		6 × 6				83.80	573.8/128990	783.6	19.27
AL1688		8 × 8				109.50	765.0/171972	1045.5	25.64

# 板式链 Leaf chains

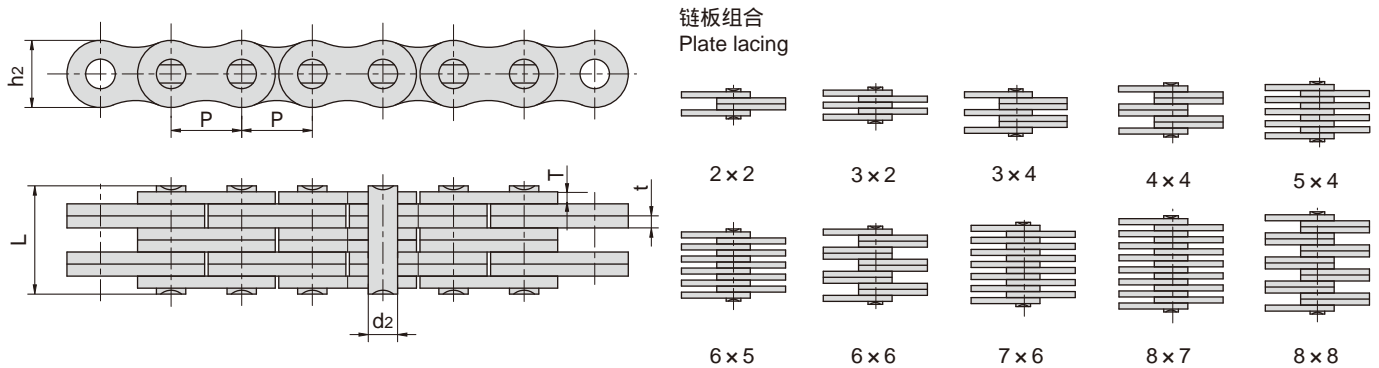

东华链号 Donghua Chain No.	节距	链板组合	链板高度	链板厚度	销轴直径	销轴长度	抗拉强度	平均抗拉强度	每米长重
	Pitch	Plate lacing	Plate depth	Plate thickness	Pin diameter	Pin length	Tensile strength	Average tensile strength	Weight per meter
	P		h <sub>2</sub> max	t/T max	d <sub>2</sub> max	L max	Q min	Q <sub>0</sub>	q
	mm		mm	mm	mm	mm	kN/lbf	kN	kg/m
FL644	5.940	4 × 4	4.7	0.60	1.85	6.2	6.50/1477	7.8	0.13
FL666		6 × 6				9.3	9.75/2216	11.8	0.20
FL688		8 × 8				12.0	13.00/2955	15.6	0.25
FL523	8.000	3 × 2	6.3	1.00	2.31	6.7	7.00/1575	7.4	0.18
*FL523F1	8.000	3 × 2	6.3	1.30/1.00	2.31	6.3	7.00/1575	7.4	0.25
*FL523F3	8.000	3 × 2	7.6	1.30/1.04	3.10	8.0	7.00/1575	8.0	0.33
*FL523F4	8.000	3 × 2	7.6	1.30/1.04	2.31	7.6	7.00/1576	8.0	0.32
FL844	8.000	4 × 4	6.9	0.73	2.31	7.9	10.00/2273	12.1	0.25
*FL823F1	8.000	3 × 2	7.6	1.30/1.04	3.15	7.8	11.00/2472	11.8	0.32
FL922	9.525	2 × 2	8.7	1.04	3.28	6.2	10.00/2273	12.1	0.22
FL944		4 × 4				10.4	21.00/4724	24.7	0.43
FL945		4 × 5				11.5	21.00/4724	23.0	0.50
FL956		6 × 5				14.0	25.50/5732	28.0	0.60
FL966		6 × 6				14.9	31.00/7045	36.8	0.65
FL988		8 × 8				19.0	42.00/9450	46.2	0.87
FL966F3		6 × 6				16.2	33.10/7441	36.5	0.75
FL922F4	2 × 2	8.6	12.50/2810	13.8	0.37				
LF10	10.000	3 × 3	7.5	1.20	3.20	10.6	14.00/3150	15.5	0.39
LF1234	12.000	4 × 3	10.0	2.03	3.96	17.6	15.45/3476	17.0	0.85
LF1246	12.000	6 × 4	10.8	1.60	5.08	18.7	30.00/6748	33.0	1.05
F1266F1	12.700	6 × 6	9.0	1.60	3.70	21.6	45.00/10123	50.0	0.92
F122	12.700	2 × 2	8.2	1.00	3.58	7.0	11.43/2598	13.6	0.19
F1223	12.700	3 × 2	10.2	2.03	4.45	12.8	20.00/4545	23.8	0.61
FL1244	12.700	4 × 4	10.2	1.70	4.45	16.7	44.00/10000	52.3	0.83
F1023	15.875	3 × 2	14.3	2.42	4.75	15.9	25.00/5625	27.5	1.11
FLC534	15.875	3 × 4	12.7	1.85	5.08	15.3	40.40/9181	44.4	0.99
FLC545		5 × 4				19.2	54.30/12340	59.7	1.27
FLC556		6 × 5				22.7	67.60/15363	74.3	1.54
FLC567		7 × 6				26.8	80.80/18176	89.0	1.82

注：带\*表示链板为直边形；带 表示链板组合特殊  
 Note: \* means straight link plate; means special link plate combination

# 板式链 Leaf chains

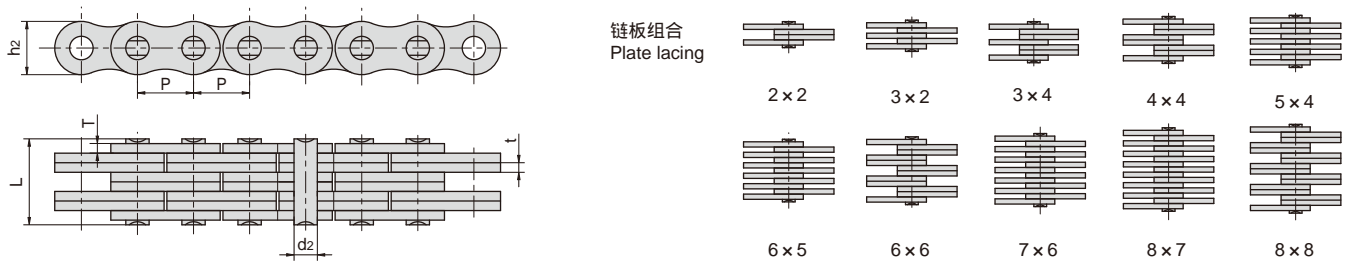

东华链号 Donghua Chain No.	节距 Pitch	链板组合 Plate lacing	链板高度 Plate depth	链板厚度 Plate thickness	销轴直径 Pin diameter	销轴长度 Pin length	抗拉强度 Tensile strength	平均抗拉强度 Average tensile strength	每米长重 Weight per meter				
	P		h2 max	t/T max	d2 max	L max	Q min	Q0	q				
	mm		mm	mm	mm	mm	kN/lbf	kN	kg/m				
FLC578	15.875	8 × 7	12.70	1.85	5.08	30.8	90.0/20250	99.0	2.10				
CTL566	15.875	6 × 6	15.10	2.10	5.08	28.0	78.0/17534	86.0	2.44				
CTBLL588	15.875	8 × 8	14.80	1.70	5.94	30.7	85.0/19108	105.0	2.59				
*CH25	17.000	2 × 1	9.00	1.60	4.00	7.5	6.0/1348	7.5	0.27				
LF1866	18.550	6 × 6	15.80	3.00	6.00	39.8	106.0/23845	116.6	3.58				
LF1966	19.050								3.53				
F19S-44	19.050	4 × 4	14.70	2.25	5.98	21.8	76.5/17210	84.5	1.55				
F19S-66		6 × 6				31.0	115.0/25870	126.5	2.31				
F19V-44	19.050	4 × 4	15.20	2.42	6.50	22.4	71.0/16136	84.3	1.73				
F19V-66		6 × 6				32.3	106.0/24090	125.9	2.57				
F19VF1-66	19.050	6 × 6	17.60	2.42	6.50	32.3	164.0/36867	180.4	3.22				
F19V-88	19.050	8 × 8	15.20	2.42	6.50	42.4	142.0/31922	156.2	3.41				
FLC623	19.050	3 × 2	14.50	1.85	5.72	12.5	30.0/6744	33.0	0.81				
FLC634	19.050	4 × 3	14.50	1.85	5.72	16.1	46.0/10341	50.6	1.12				
FL2044	20.000	4 × 4	16.00	2.42	5.30	22.4	67.0/15062	73.7	1.83				
FLC823	25.400	3 × 2	19.46	3.25	8.28	20.9	65.0/14612	72.0	1.86				
FLC834		4 × 3				27.4	100.0/22500	110.0	2.57				
FLC845		5 × 4				34.2	130.0/29224	143.0	3.30				
FLC856		6 × 5				40.5	166.0/37343	183.0	4.00				
FLC867		7 × 6				47.0	195.7/44024	215.3	4.70				
FLC878		8 × 7				53.6	227.5/51180	250.5	5.40				
F25-34		25.400				3 × 4	23.40	3.05/4.00	10.85	28.6	125.0/28120	137.5	3.64
F25-66	6 × 6		44.1	250.0/56240	275.0	5.93							
F25-66F1	25.000	6 × 6	24.00	3.00	10.85	42.0	147.0/33046	190.0	5.65				
FLC1034	31.750	4 × 3	25.40	3.25	9.53	28.4	82.7/18591	91.0	3.52				
FLC1045		5 × 4				34.3	110.0/24745	121.0	4.49				
FLC1056		6 × 5				40.6	137.9/31340	151.0	5.44				
FLC1067		7 × 8				47.2	165.4/37590	181.9	6.42				
FLC1078		8 × 7				53.8	193.0/43863	212.0	7.40				
LF31109		31.750				10 × 9	27.00	4.00	12.00	83.0	440.0/98915	500.0	12.70
P35-44		35.000				4 × 4	30.00	4.00	12.00	37.7	100.0/22500	110.0	5.96
LF8844F1	88.900	4 × 4	84.00	13.50	40.00	122.0	1950.0/438360	2145.0	60.60				
D90F1	90.000	8 × 8	70.00	6.30	36.00	113.0	980.0/220460	1078.0	41.20				
LF105	105.000	11 × 10	80.00	6.00	40.00	143.0	1470.0/330690	1690.5	64.38				

注：\*表示链板为直边形；带 表示链板组合特殊  
Note: \* means straight link plate; means special link plate combination

# 板式链 Leaf chains

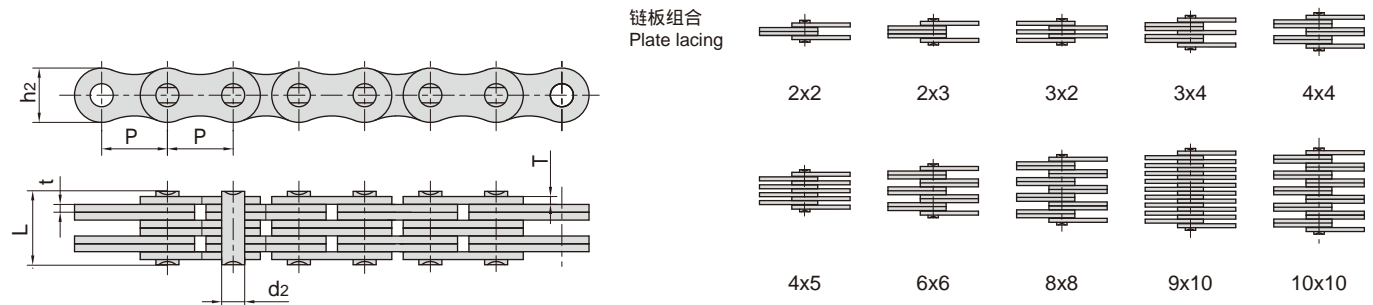

东华链号 Donghua Chain No.	节距 Pitch	链板组合 Plate lacing	链板高度 Plate depth	链板厚度 Plate thickness	销轴直径 Pin diameter	销轴长度 Pin length	抗拉强度 Tensile strength	平均抗拉强度 Average tensile strength	每米长重 Weight per meter
	P		h <sub>2</sub> max	t/T max	d <sub>2</sub> max	L max	Q min	Q <sub>0</sub>	q
	mm		mm	mm	mm	mm	kN/lbf	kN	kg/m
AL0522	8.000	2 × 2	7.10	0.80	2.31	5.00	4.40/990	4.6	0.15
AL0544		4 × 4				8.20	8.80/1980	9.3	0.28
AL0566		6 × 6				11.60	13.00/2922	13.7	0.42
AL322F1	9.525	2 × 2	7.00	1.30	3.58	7.50	9.30/2092	9.8	0.22
AL344F1		4 × 4				12.80	18.50/4162	19.4	0.42
AL366F1		6 × 6				18.20	27.80/6254	29.2	0.62
AL388F1		8 × 8				23.60	37.00/8323	38.8	0.82
AL322HF2	9.525	2 × 2	7.70	1.50	3.58	7.60	10.00/2248	10.5	0.24
*AL344F3	9.525	4 × 4	7.70	1.20	3.58	11.60	18.00/4046	18.9	0.49
AL344F4	9.525	4 × 4	7.90	1.57	3.58	15.00	25.00/5620	26.3	0.63
AL866F1	25.400	6 × 6	20.50	3.00	7.92	40.30	135.00/30370	148.5	4.40
AL822F3	25.400	2 × 2	20.80	3.25	7.92	15.90	57.90/13016	70.0	1.61
AL10910F1	31.750	10 × 9	27.00	4.00	12.00	83.00	400.00/89923	441.0	11.80
AL1066F2	31.750	6 × 6	25.60	4.00	9.53	52.20	265.00/59574	305.0	7.43
AL1044F1	31.750	4 × 4	22.80	4.15	10.19	37.90	214.00/48107	234.5	4.32
AL1266F1	38.100	6 × 6	30.00	4.80	13.30	64.30	420.00/94482	462.0	9.68
BL432F1	12.700	3 × 2	11.60	2.03	4.45	12.60	22.00/4946	24.0	0.76
LH0844F5	12.700	4 × 4	12.07	1.60	5.08	16.00	27.50/6182	30.0	1.01
LH0832F6	12.700	3 × 2	12.07	2.03	4.45	13.16	19.80/4451	23.0	0.77
LH081010F8	12.700	10x10	12.07	2.03	5.94	44.80	120.00/26977	130.0	6.35
LH0844F	12.700	4 × 4	12.07	1.60	5.08	15.70	44.48/10000	48.9	1.01
BL544F1	15.875	4 × 4	14.60	2.37	5.94	22.50	80.00/17985	85.0	1.76
LH1034F2	15.875	3 × 4	15.00	2.42	5.94	20.30	65.00/14612	70.0	1.64
BL544F8	15.875	4 × 4	15.00	1.70	5.80	17.00	46.00/10341	53.0	1.33
LH1223F1	19.050	2 × 3	15.60	2.42	5.94	20.30	29.40/6610	32.5	1.50
LH1245F1		4 × 5				25.20	39.20/8812	43.0	1.91
LH1223F3	19.050	2 × 3	18.10	3.25	7.93	19.90	68.65/15433	71.0	1.95
LH1234F3		3 × 4				26.60	102.97/23148	108.8	2.69

注：带\*表示链板为直边形；带 表示链板组合特殊  
 Note: \* means straight link plate; means special link plate combination



# 板式链 Leaf chains

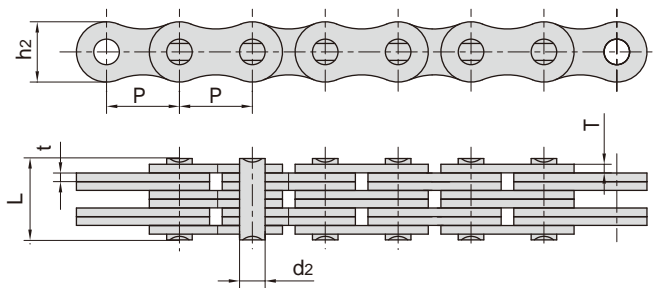

链板组合  
Plate lacing

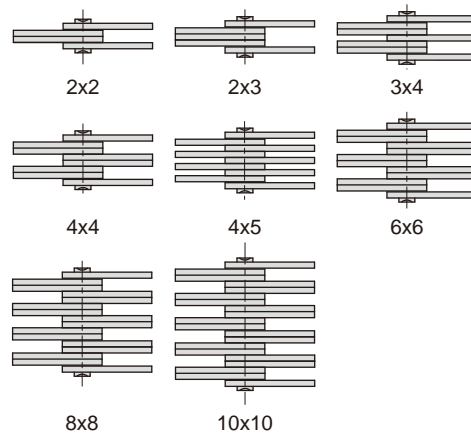

东华链号 Donghua Chain No.	节距 Pitch	链板组合 Plate lacing	链板高度 Plate depth	链板厚度 Plate thickness	销轴直径 Pin diameter	销轴长度 Pin length	抗拉强度 Tensile strength	平均抗拉强度 Average tensile strength	每米长重 Weight per meter
	P		h <sub>2</sub> max	t/T max	d <sub>2</sub> max	L max	Q min	Q <sub>0</sub>	q
	mm		mm	mm	mm	mm	kN/lbf	kN	kg/m
BL666F1	19.050	6 x 6	18.10	2.35	6.50	31.70	130.0/29224	143.0	3.30
*BL666GL	19.050	6 x 6	16.00	3.00	6.25	40.00	100.0/22480	110.0	3.80
BL866F1	25.400	6 x 6	24.10	3.10/4.00	10.85	45.70	200.0/44992	220.0	6.14
BL834F2		3 x 4				29.50	120.0/26995	132.0	3.76
BL834F3	25.400	3 x 4	24.10	4.00	10.90	32.90	142.0/31944	156.2	4.44
BL866F3		6 x 6				52.20	253.6/57050	279.0	7.48
BL834F5	25.400	3 x 4	24.10	3.10/4.00	10.90	28.00	120.0/26995	132.0	3.64
BL866F5	25.400	6 x 6	24.10	3.30/4.00	10.90	45.30	200.0/44992	220.0	4.94
LH1646F3	25.400	4 x 6	24.10	4.00	9.53	44.20	233.0/52378	256.5	6.22
BL844F8	25.400	4 x 4	25.10	3.00	10.90	30.00	120.0/26976	135.0	3.84
LH2066F1	31.750	6 x 6	29.70	4.09	11.10	55.70	303.0/68177	365.0	9.42
BL1046F2	31.750	4 x 6	29.70	4.00	11.10	47.00	231.3/51996	266.0	7.74
LH2054F4	31.750	5 x 4	29.70	5.60	11.10	56.50	280.0/62947	340.0	9.56
LH281010F1	44.450	10x10	36.10	5.00	14.27	108.00	1220.0/274256	1400.0	22.20
LH3288F1	50.800	8 x 8	47.80	6.90	20.20	122.00	1200.0/269950	1320.0	33.53
LH3266F2	50.800	6 x 6	48.20	7.00	17.46	91.80	867.0/195040	953.7	24.52
LH3244F6	50.800	4 x 4	42.00	6.00	17.46	56.00	430.0/96667	505.0	11.96
LH3288F9	50.800	8 x 8	48.20	6.40	17.46	112.00	1040.0/233792	1144.0	31.89
LH3288F10	50.800	8 x 8	48.20	9.50	19.84	164.20	2100.0/472080	2310.0	51.63
LL0622F4	9.525	2 x 2	8.40	1.04	3.28	6.20	10.0/2248	10.5	0.23
LL0634F4		3 x 4				9.70	15.5/3484	16.5	0.39
LL0644F4		4 x 4				10.70	21.0/4720	22.0	0.44
LL0666F4		6 x 6				14.90	31.0/6970	33.0	0.65

注：带\*表示链板为直边形；带 表示链板组合特殊  
Note: \* means straight link plate; means special link plate combination

# 板式链 Leaf chains

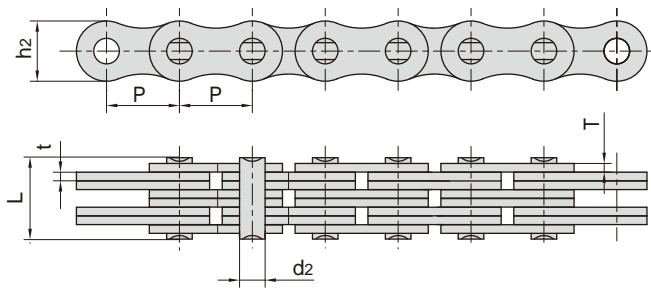

链板组合  
Plate lacing

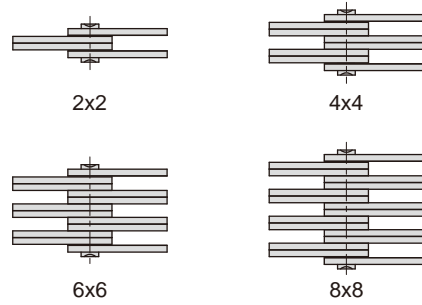

东华链号 Donghua Chain No.	节距 Pitch	链板组合 Plate lacing	链板高度 Plate depth	链板厚度 Plate thickness	销轴直径 Pin diameter	销轴长度 Pin length	抗拉强度 Tensile strength	平均抗拉强度 Average tensile strength	每米长重 Weight per meter
	P		h <sub>2</sub> max	t/T max	d <sub>2</sub> max	L max	Q min	Q <sub>0</sub>	q
	mm		mm	mm	mm	mm	kN/lbf	kN	kg/m
LL0622F7	9.525	2 x 2	8.20	1.30	3.28	7.40	10.5/2360	11.6	0.27
LL0644F7		4 x 4				12.80	21.0/4720	23.0	0.52
LL0844F6	12.700	4 x 4	11.00	1.50	4.45	14.60	37.6/8452	81.4	0.82
LL0888F1		8 x 8				27.40	77.0/17310	85.0	1.61
LL0844F7	12.700	4 x 4	11.20	1.60	4.45	15.60	36.4/8180	41.5	0.85
LL0822F13	12.700	2 x 2	10.60	1.70	4.45	9.40	22.0/4940	23.0	0.45
LL0844F13		4 x 4				16.50	40.0/8990	43.0	0.88
LL0888F2	12.700	8 x 8	11.00	1.43	4.45	25.90	77.0/17310	84.7	1.55
LL1044F7	15.875	4 x 4	13.70	1.50	5.08	15.10	48.0/10790	52.8	1.04
LL1066F3	15.875	6 x 6	13.70	1.80	5.08	24.50	86.0/19333	94.6	1.68
LL101212F4	15.875	12x12	11.80	1.60	5.08	42.50	110.0/24728	121.0	2.47
LL101212F5	15.875	12x12	13.70	1.50	5.08	40.50	136.2/30620	150.0	3.00
LL1266F2	19.050	6 x 6	14.50	3.00	5.72	39.50	156.8/35249	173.0	3.03
LL1266F3	19.050	6 x 6	16.00	3.00	5.72	39.50	88.5/19895	97.5	3.03
*LL1266H	19.050	6 x 6	16.13	3.00	5.72	40.00	86.7/19490	100.0	3.75
LL1266F6	19.050	6 x 6	18.50	2.90	5.72	38.75	88.2/19827	97.0	4.12
LL1622F6	25.400	2 x 2	20.00	3.00	8.28	15.60	58.0/13047	63.8	1.40
LL2066F6	31.750	6 x 6	30.20	4.00	13.74	56.10	310.0/69690	356.5	13.13
LL3244F2	50.800	4 x 4	43.10	6.00	17.76	54.00	520.0/116978	572.0	12.62
LL3244F8	50.800	4 x 4	42.00	6.00	17.81	57.00	520.0/116900	560.0	12.31
LL3288F8		8 x 8				105.50	1040.0/233800	1125.0	24.32
LL4088F2	63.500	8 x 8	52.70	8.20	22.89	140.00	1440.0/323725	1660.0	42.39
LL4888H	76.200	8 x 8	70.00	12.00	36.50	204.00	2630.0/591638	2893.0	83.80

注：带\*表示链板为直边形；带 表示链板组合特殊  
 Note: \* means straight link plate; means special link plate combination

# 板式链 Leaf chains

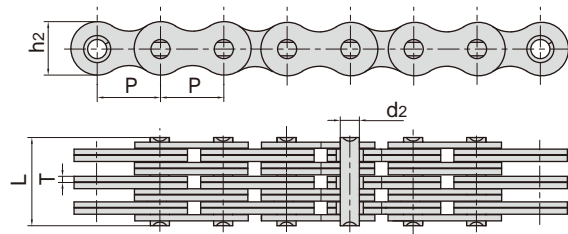

东华链号 Donghua Chain No.	节距 Pitch	链板组合 Plate lacing	链板高度 Plate depth	链板厚度 Plate thickness	销轴直径 Pin diameter	销轴长度 Pin length	抗拉强度 Tensile strength	平均抗拉强度 Average tensile strength	每米长重 Weight per meter
	P mm		h2 max mm	T max mm	d2 max mm	L max mm	Q min kN/lbf	Q0 kN	q kg/m
FB156	15.875	6 × 6	14.7	1.70	5.08	24.0	78.0/17550	86.0	1.91
FB156S				2.03		27.5	83.5/18784	92.0	2.24
FB196	19.050	6 × 6	16.0	1.85	5.72	25.4	95.0/21371	105.0	1.94
FB196S				2.42		32.3	130.0/29244	143.0	3.37

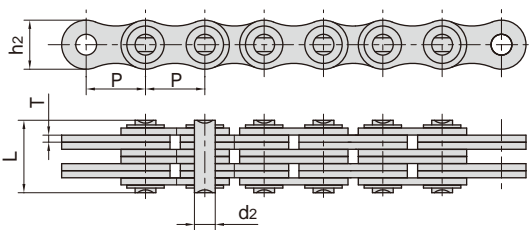

链板组合  
Plate lacing

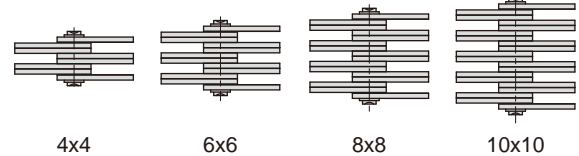

东华链号 Donghua Chain No.	节距 Pitch	链板组合 Plate lacing	链板高度 Plate depth	链板厚度 Plate thickness	销轴直径 Pin diameter	销轴长度 Pin length	抗拉强度 Tensile strength	平均抗拉强度 Average tensile strength	每米长重 Weight per meter
	P mm		h2 max mm	T max mm	d2 max mm	L max mm	Q min kN/lbf	Q0 kN	q kg/m
BL1266F1	38.1	6 × 6	35.7	5.6	12.70	78.9	453.7/102063	499.0	15.69
BL1666F4	50.8	6 × 6	48.2	7.2	17.46	99.2	867.0/195040	953.7	27.27
LL2488F1	38.1	8 × 8	33.4	5.0	14.63	94.0	680.0/152864	748.0	16.71
LL3244F1	50.8	4 × 4	42.0	6.0	17.81	61.6	520.0/116978	572.0	12.90
LL3266F1		6 × 6				86.0	780.0/175467	858.0	18.90
LL3288F1		8 × 8				110.0	1040.0/233956	1144.0	24.89
LL321010F1		10 × 10				134.3	1300.0/292445	1430.0	30.89
LL3244F3	50.8	4 × 4	43.1	6.0	17.76	60.0	520.0/116978	572.0	13.06
LL3266F3		6 × 6				84.4	780.0/175467	858.0	19.44
LL3288F3		8 × 8				108.6	1040.0/233956	1144.0	25.43
LL3244F4	50.8	4 × 4	42.0	6.4	17.81	67.5	520.0/116980	572.0	13.82
LL3266F4		6 × 6				92.8	780.0/175467	858.0	20.17
LL3288F7		8 × 8				117.0	1040.0/233800	1144.0	26.30
LL4066F1		6 × 6				100.0	1166.2/262162	1283.0	29.30
LL4088F1	63.5	8 × 8	57.5	6.3	19.85	126.0	1558.2/350283	1714.0	38.10
LL4088F3		8 × 8				119.0	1395.0/313596	1535.0	35.79
LL4044F4	63.5	4 × 4	52.7	8.0	22.89	80.8	780.0/175351	860.0	21.82
LL4888F3	76.2	8 × 8	73.0	7.2	34.67	138.5	1840.0/413632	2024.0	56.02
LL481010F3		10 × 10				165.5	2340.0/526032	2574.0	69.18

# 板式链

## Leaf chains

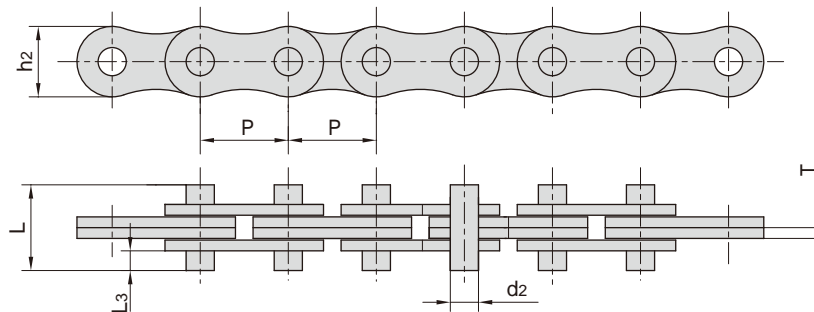

东华链号 Donghua Chain No.	节距	链板高度	链板厚度	销轴直径	销轴长度		抗拉强度	平均抗拉强度	每米长重
	Pitch	Plate depth	Plate thickness	Pin diameter	Pin length		Tensile strength	Average tensile strength	Weight per meter
	P	h2 max	T max	d2 max	L max	L3	Q min	Q0	q
	mm	mm	mm	mm	mm	mm	kN/lbf	kN	kg/m
AL422F1 - D2	12.700	11.00	1.60	3.96	14.4	3.80	14.10/3172	15.5	0.50
AL522 - D2	15.875	12.80	2.03	5.10	16.0	3.90	22.00/4950	23.0	0.69
AL522 - D2F1					19.0	5.40			
AL522F1 - D2	15.800	12.70	2.00	5.09	16.1	3.90	30.38/6834	32.0	0.66
AL622 - DD3F1	19.050	16.90	3.25	5.94	22.3	4.40	50.00/11240	55.0	1.44
AL644F4 - D2	19.050	14.60	3.10	5.90	22.5	4.90	36.00/8093	40.0	1.14
BL422 - DD3	12.700	12.07	2.03	5.08	31.4	11.50	22.24/50000	24.5	0.91
LH1222 - D2	19.050	18.10	3.25	7.92	22.6	4.60	48.93/11000	54.0	1.66
LH1222F7 - DD3					29.4	8.00	48.93/11001	55.0	1.80
LH1222 - DD3F1					29.0	7.75	48.93/10999	53.8	1.80
LH1246 - DD3F1					42.5	4.75	97.90/22008	112.5	3.88
LH1622F1	25.400	24.10	4.00	9.53	34.0	8.80	84.50/19010	93.0	2.40
LH1622 - D2					36.0	9.80			2.83
LH1622 - DD3F1					45.0	14.30			3.04
LH1622 - DD3F2					25.4	4.45			2.60
BL822F1 - D2	25.400	24.10	4.60	8.80	32.4	6.80	84.50/19010	93.0	3.03
BL822HF1 - D2				9.53	32.4	3.07			
BL822HF2 - DD3	25.400	24.00	5.00	9.53	35.0	7.05	84.50/19010	97.5	2.55
BL1022F1 - D2	31.750	29.00	5.60	11.30	41.2	8.40	130.00/29245	143.0	4.49
BL1022H - D2	31.750	29.70	5.60	11.10	41.2	8.40	130.00/29245	143.0	4.69
LH2022 - DD3F1	31.750	29.70	4.80	11.10	30.4	5.50	115.60/25987	127.2	3.89
LL1222F3 - D2	19.050	14.50	2.25	5.72	22.0	6.30	44.10/9920	48.5	0.89
LL1222F5 - DD3	19.050	14.50	3.00	5.72	29.0	8.30	45.10/10139	49.5	1.17
LL1222F5 - DD3F1	19.050	14.50	3.00	5.72	22.0	4.80	45.10/10140	50.5	1.10
LL1622 - D2	25.400	21.00	3.10	8.28	36.1	11.70	58.00/13050	64.0	1.92
LL1622F7 - DD3	25.400	21.00	3.05	8.28	35.0	11.20	75.40/16950	79.2	1.85
LL1622F7 - DD3F1	25.400	20.00	3.00	8.28	30.5	9.00	58.00/13040	63.8	1.65
LL1623F1 - DD3	25.400	21.00	4.00	8.28	34.0	7.00	60.00/13488	66.0	2.70
F1422 - DD3	14.290	13.00	2.03	4.97	19.1	5.20	27.50/6182	30.0	0.76
1922V - D2	19.050	16.70	3.17	6.10	22.6	4.65	55.00/12364	60.5	1.40
F2022 - D2	20.750	19.00	3.40	7.65	23.0	4.50	50.00/11500	55.0	1.79
F2422 - D2	23.950	22.20	3.86	8.69	27.8	5.90	60.00/13500	66.0	2.37
F2422F1 - D2	24.000	22.00	4.00	9.00	27.0	5.40	60.00/13500	66.0	2.39

# 板式链 Leaf chains

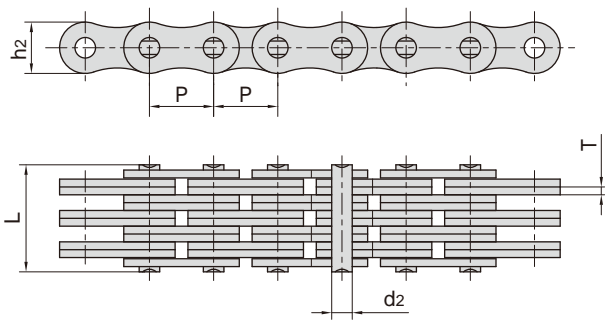

链板组合  
Plate lacing

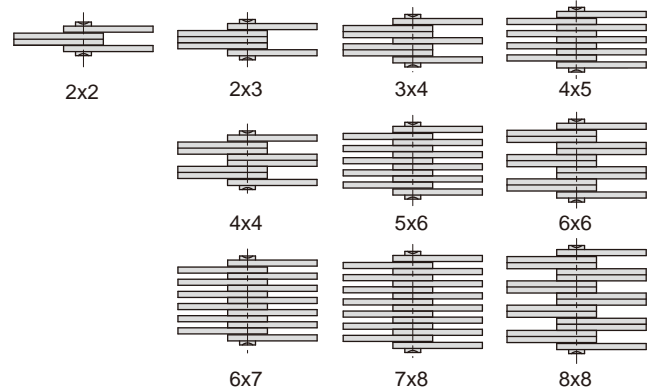

东华链号 Donghua Chain No.	节距	链板组合	链板高度	链板厚度	销轴直径	销轴长度	链条长度(100节)	抗拉强度	每米长重
	Pitch	Plate lacing	Plate depth	Plate thickness	Pin diameter	Pin length	Chain length for 100 pitches (± 0.25%)	Tensile strength	Weight per meter
	P		h2 max	T max	d2 max	L max		Q min	q
	mm		mm	mm	mm	mm	mm	kN/lbf	kg/m
1222	12.700	2 × 2	10.6	1.70	4.45	9.2	1262	21.0/4721	0.44
1234		3 × 4				14.2		31.0/6974	0.75
1244		4 × 4				16.1		42.0/9442	0.86
1256		5 × 6				21.1		53.0/12045	1.17
1266		6 × 6				23.0		63.0/14162	1.27
1288		8 × 8				29.9		85.0/19318	1.70
1523	15.875	2 × 3	12.7	1.94	5.08	12.1	1580	29.0/6590	0.75
1534		3 × 4				16.5		46.0/10454	1.04
1543		4 × 3				16.5		46.0/10455	1.05
1544		4 × 4				18.6		58.0/13181	1.18
1545		4 × 5				20.3		58.0/13181	1.33
1556		5 × 6				24.0		72.0/16363	1.63
1566		6 × 6				26.2		87.0/19772	1.77
1567		6 × 7				28.0		90.0/20454	1.91
1578		7 × 8				32.5		101.0/22954	2.20
1588	8 × 8	34.0	115.0/26136	2.34					
1944	19.050	4 × 4	15.0	2.29	5.72	21.3	1891	73.0/16590	1.58
1966		6 × 6				30.7		110.0/25000	2.37
1978		7 × 8				37.7		122.0/27426	2.98
1988		8 × 8				40.0		140.0/31817	3.13

注：带 表示链板组合特殊  
Note: means special link plate combination

# 板式链 Leaf chains

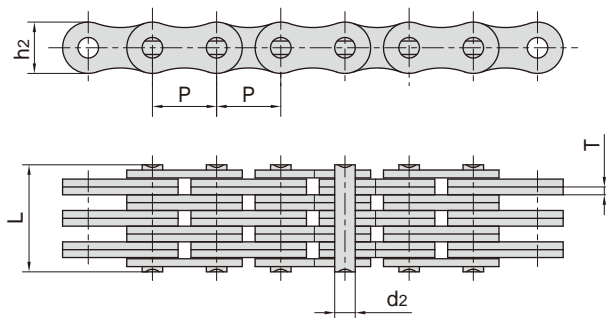

链板组合  
Plate lacing

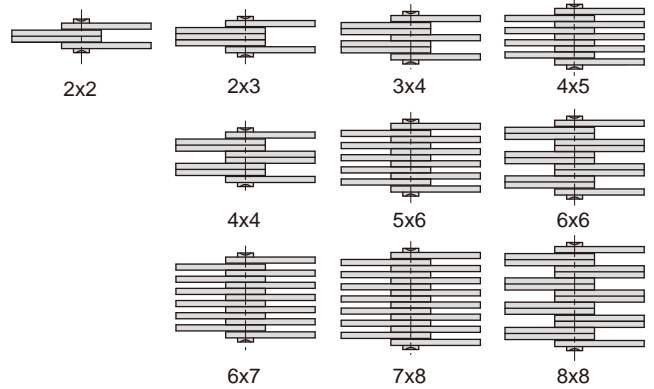

东华链号 Donghua Chain No.	节距	链板组合	链板高度	链板厚度	销轴直径	销轴长度	链条长度(100节)	抗拉强度	每米长重
	Pitch	Plate lacing	Plate depth	Plate thickness	Pin diameter	Pin length	Chain length for 100 pitches (± 0.25%)	Tensile strength	Weight per meter
	P		h <sub>2</sub> max	T max	d <sub>2</sub> max	L max		Q min	q
	mm		mm	mm	mm	mm	mm	kN/lbf	kg/m
2522	25.400	2 × 2	20.2	3.06	8.28	15.5	2532	72.00/16186	1.47
2523		2 × 3				18.8		72.00/16363	1.83
2534		3 × 4				25.3		108.00/24545	2.55
2544		4 × 4				29.5		145.00/32597	2.92
2545		4 × 5				31.6		144.00/30727	3.26
2556		5 × 6				38.2		180.00/40908	3.96
2567		6 × 7				43.8		216.00/49090	4.68
2578		7 × 8				50.0		252.00/57272	5.39
2588		8 × 8				52.8		290.00/65908	5.77
3134	31.750	3 × 4	22.8	4.10	10.19	33.3	3168	160.00/35968	4.16
3144		4 × 4				37.5		214.00/48109	4.24
3166		6 × 6				54.3		304.00/68339	6.33
3188		8 × 8				71.1		428.00/96214	8.40
1244F3	12.700	4 × 4	11.0	1.43	4.45	13.9	1262	24.97/7861	0.78
1266F1		6 × 6				19.9		52.46/7861	1.06